

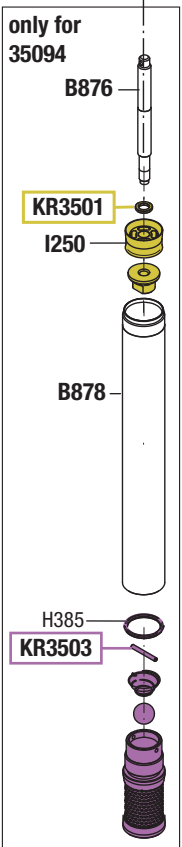

VISTA ESPLOSA - EXPLODED VIEW

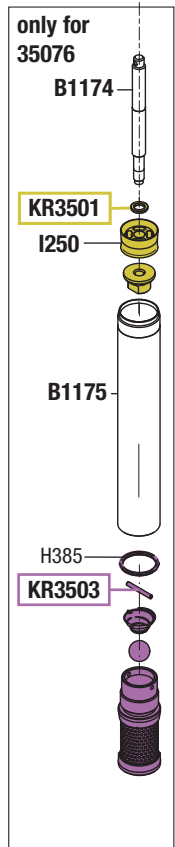

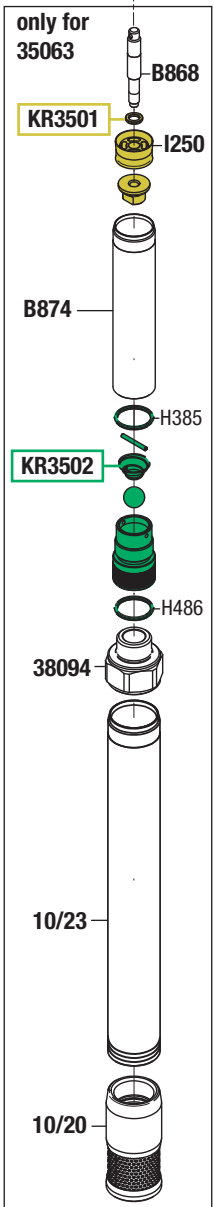
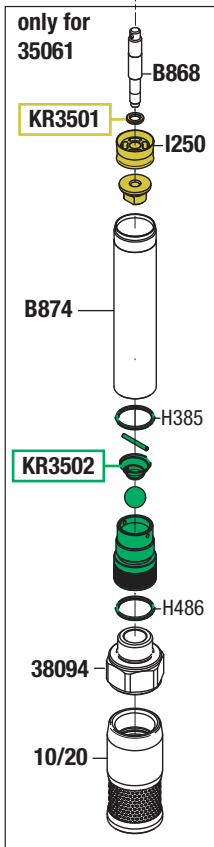
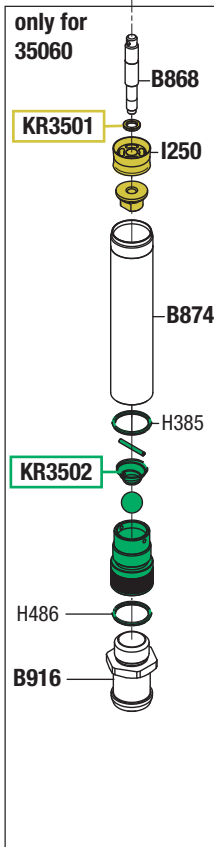
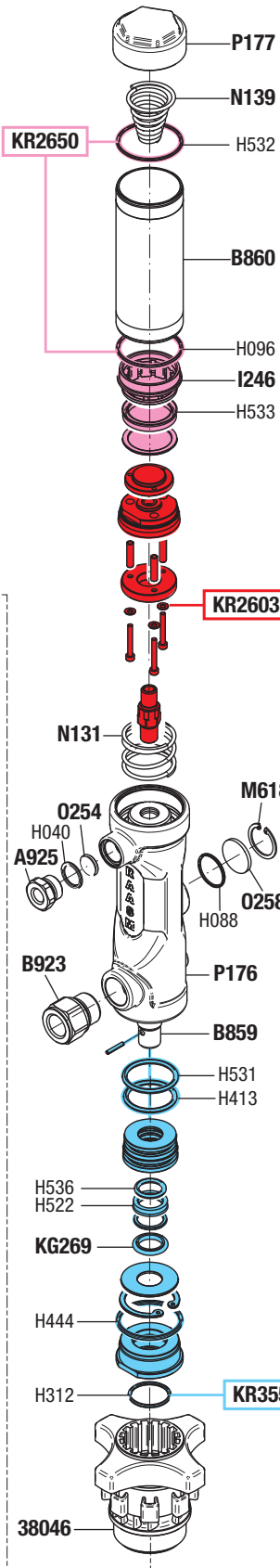
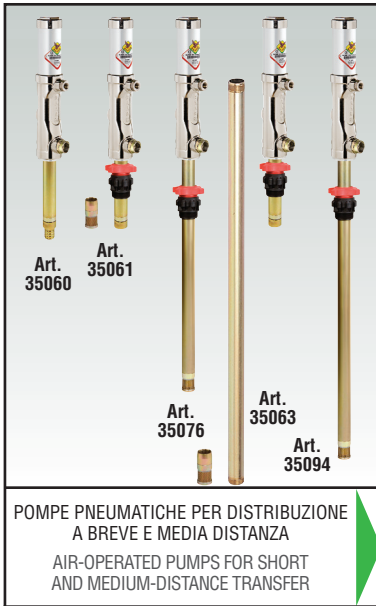

GUIDA RICAMBI - SPARE PARTS GUIDE

KIT RICAMBI
OGNI KIT SOTTO RIPORTATO COMPRENDE I RICAMBI EVIDENZIATI CON LO STESSO COLORE E LE RELATIVE GUARNIZIONI. QUESTI RICAMBI NON SONO FORNIBILI SEPARATAMENTE TRANNE QUELLI CODIFICATI.

SPARE PARTS KITS
EACH KIT SHOWN WITH THE SAME COLOR INCLUDES ALSO THE GASKETS. THE SPARE PARTS INCLUDED IN THE KIT CAN'T BE SUPPLIED SEPARATELY EXCEPT THOSE SHOWN WITH A PROPER CODE.

CODICE CODE	DESCRIZIONE DESCRIPTION	Q. TÀ QTY
KR2603	GRUPPO PISTONE MOTORE POMPANTE PUMPING MOTOR PISTON GROUP	1
KR2650	GR. TRAVASO ARIA SLIDE VALVE GROUP	1
KR3501	PISTONE POMPANTE PUMPING PISTON	1
KR3502	VALVOLA FONDO PESCANTE BOTTOM VALVE	1
KR3503	VALVOLA FONDO PESCANTE BOTTOM VALVE	1
KR3551	PACCO GUARNIZIONI GASKETS SET	1

ELENCO RICAMBI FORNIBILI SINGOLARMENTE
LIST OF SPARE PARTS WHICH CAN BE SUPPLIED SEPARATELY

CODICE CODE	DESCRIZIONE DESCRIPTION	Q. TÀ QTY
10/20	VALVOLA FONDO PESCANTE Art. 35061 BOTTOM VALVE Art. 35061	1
10/23	PROLUNGA PESCANTE 960 mm Art. 35063 SUCTION TUBE EXTENSION 960 mm Art.35063	1
38046	GHIERA DI BLOCCAGGIO ø 32 mm BUNG ADAPTOR ø 32 mm	1
38094	ADATTATORE PER PROLUNGA ADAPTOR FOR EXTENSION	1
A925	ADATTATORE M 1/2" G x F 1/4" G ADAPTOR M 1/2" G x F 1/4" G	1
B859	PISTONE BASCULANTE PISTON	1
B860	TUBO PISTONE PISTON TUBE	1
B868	STELO POMPANTE Art. 35060 - 35061 - 35063 PUMPING ROD Art. 35060 - 35061 - 35063	1
B874	TUBO PESCANTE Art. 35060 - 35061 - 35063 SUCTION TUBE Art. 35060 - 35061 - 35063	1
B876	STELO POMPANTE Art. 35094 PUMPING ROD Art. 35094	1
B878	TUBO PESCANTE Art. 35094 SUCTION TUBE Art. 35094	1
B916	PORTATUBO A RESCA Art. 35060 HOSE HOLDER Art. 35060	1
B923	RACCORDO CONNECTOR	1
B1174	STELO POMPANTE Art. 35076 PUMPING ROD Art. 35076	1
B1175	TUBO PESCANTE Art. 35076 SUCTION TUBE Art. 35076	1
I246	ANELLO TRAVASO ARIA SLIDE VALVE RING	1
M618	ANELLO SEEGER ø 30 mm SEEGER RING ø 30 mm	1
N131	MOLLA SPRING	1
N139	MOLLA CONICA CONIC SPRING	1
P176	CORPO POMPA PUMP BODY	1
P177	TAPPO POMPA PUMP PLUG	1

Art. KR3357
KIT GUARNIZIONI COMPLETO
COMPOSTO DALLE GUARNIZIONI SOTTO ELENCAE
JOINTS GASKETS LIST
INCLUDING ALL THE GASKETS SHOWN HERE UNDER

CODICE CODE	DESCRIZIONE DESCRIPTION	Q. TÀ QTY
H040	O-RING 123 O-RING 123	1
H088	O-RING 2106 "NBR 70" O-RING 2106 "NBR 70"	1
H096	O-RING 3168 O-RING 3168	1
H312	O-RING 3118 "VITON" O-RING 3118 "VITON"	1
H385	O-RING 3100 "VITON" O-RING 3100 "VITON"	1
H413	O-RING 4150 "VITON" O-RING 4150 "VITON"	1
H444	O-RING 3193 "VITON" O-RING 3193 "VITON"	1
H486	O-RING 3093 "VITON" O-RING 3093 "VITON"	1
H522	GUARNIZIONE "VITON" GASKET "VITON"	1
H531	O-RING 4143 "VITON" O-RING 4143 "VITON"	1
H532	O-RING O-RING	1
H533	GUARNIZIONE GASKET	1
H536	O-RING 4075 "VITON" O-RING 4075 "VITON"	1
I250	PISTONE POMPANTE PUMPING PISTON	1
KG269	ANELLO DI TENUTA "TEFLON-VITON" GASKET "TEFLON-VITON"	1
O254	SILENZIATORE A PASTICCA MUFFLER	1
O258	SILENZIATORE A PASTICCA MUFFLER	1

Art. KS3386
SET RICAMBI CONSIGLIATI
AI PUNTI VENDITA E ASSISTENZA.
COMPOSTO DAI RICAMBI SOTTO ELENCAE
SPARE PARTS KIT ADVISED
TO THE REPAIR CENTERS. THIS KIT INCLUDES
ALL THE SPARE PARTS SHOWN HERE UNDER

CODICE CODE	DESCRIZIONE DESCRIPTION	Q. TÀ QTY
KR2603	GRUPPO PISTONE MOTORE POMPANTE PUMPING MOTOR PISTON GROUP	1
KR3357	KIT GUARNIZIONI COMPLETO COMPLETE GASKETS KIT	1
N131	MOLLA SPRING	1
N139	MOLLA CONICA CONIC SPRING	1